

Submersible Waste Water Pump

Ama-Drainer 80/100

Installation/Operating Manual



Legal information/Copyright

Installation/Operating Manual Ama-Drainer 80/100

Original operating manual

All rights reserved. The contents provided herein must neither be distributed, copied, reproduced, edited or processed for any other purpose, nor otherwise transmitted, published or made available to a third party without the manufacturer's express written consent.

Subject to technical modification without prior notice.

© KSB SE & Co. KGaA, Frankenthal 09/01/2018

Contents

	Glossary	5
1	General.....	6
	1.1 Principles	6
	1.2 Installation of partly completed machinery.....	6
	1.3 Target group.....	6
	1.4 Other applicable documents.....	6
	1.5 Symbols	6
2	Safety.....	7
	2.1 Key to safety symbols/markings.....	7
	2.2 General.....	7
	2.3 Intended use	7
	2.4 Personnel qualification and training.....	8
	2.5 Consequences and risks caused by non-compliance with this manual	8
	2.6 Safety awareness	8
	2.7 Safety information for the operator/user	9
	2.8 Safety information for maintenance, inspection and installation	9
	2.9 Unauthorised modes of operation	9
3	Transport/Temporary Storage/Disposal.....	10
	3.1 Checking the condition upon delivery	10
	3.2 Transport.....	10
	3.3 Storage/preservation	10
	3.4 Return to supplier.....	10
	3.5 Disposal	11
4	Description of the Pump (Set).....	12
	4.1 General description	12
	4.2 Designation.....	12
	4.3 Name plate.....	13
	4.4 Design details.....	13
	4.5 Configuration and function.....	15
	4.6 Scope of supply.....	16
	4.7 Noise characteristics	16
	4.8 Dimensions and weights	16
5	Installation at Site	17
	5.1 Safety regulations.....	17
	5.2 Checks to be carried out prior to installation.....	17
	5.2.1 Checking the operating data	17
	5.2.2 Preparing the place of installation	17
	5.3 Installing the pump set	18
	5.4 Piping	18
	5.4.1 Connecting the piping.....	18
	5.5 Electrical system.....	19
	5.5.1 Information for planning the control system	19
	5.5.2 Electrical connection.....	20
	5.6 Checking the direction of rotation.....	21
6	Commissioning/Start-up/Shutdown.....	23
	6.1 Commissioning/Start-up.....	23
	6.1.1 Prerequisites for commissioning/start-up	23
	6.1.2 Starting up/switching off the pump set	23
	6.2 Operating limits.....	23
	6.2.1 Frequency of starts.....	23
	6.2.2 Supply voltage.....	24
	6.2.3 Fluid handled	24
	6.3 Shutdown/storage/preservation	25

6.3.1	Measures to be taken for shutdown	25
6.4	Returning to service	25
7	Operation.....	26
7.1	Controlling an Ama-Drainer 80	26
8	Servicing/Maintenance.....	27
8.1	Safety regulations.....	27
8.2	Maintenance/inspection.....	27
8.2.1	Lubrication and lubricant change.....	28
8.3	Drainage/disposal	29
8.4	Dismantling the pump set.....	30
8.4.1	General information/Safety regulations.....	30
8.4.2	Dismantling the pump section	30
8.4.3	Dismantling casing insert 13-6 (variant B/BH only).....	30
8.4.4	Removing the mechanical seal.....	31
8.4.5	Removing the ball bearings	31
8.5	Reassembling the pump set.....	31
8.5.1	General information/Safety regulations.....	31
8.5.2	Installing the ball bearings.....	32
8.5.3	Installing the mechanical seal	32
8.5.4	Fitting casing insert 13-6 (variant B/BH only)	32
8.5.5	Installing the pump section.....	32
8.6	Recommended spare parts stock	33
9	Trouble-shooting.....	34
10	Related Documents	36
10.1	Exploded view and list of components	36
10.2	Dimensions.....	38
10.2.1	Ama-Drainer 80.....	38
10.2.2	Ama-Drainer 100.....	39
10.3	Installation example	40
10.3.1	Single pump (installation example)	40
10.3.2	Dual-pump station (installation example).....	41
10.4	Wiring diagrams	42
10.4.1	Ama-Drainer (B) 80-40	42
10.4.2	Ama-Drainer (B) 100-75 N, S.....	43
11	EU Declaration of Conformity	44
12	Certificate of Decontamination.....	45
	Index	46

Glossary

Backflow

Waste water flowing back from the sewer into the connected drainage piping

Certificate of decontamination

A certificate of decontamination is enclosed by the customer when returning the product to the manufacturer to certify that the product has been properly drained to eliminate any environmental and health hazards arising from components in contact with the fluid handled.

Close-coupled design

Motor directly fitted to the pump via a flange or a drive lantern

Discharge line

Pipe for transporting waste water to a level above the flood level into the sewer system

EN 12050-2

European Standard for waste water lifting units which are used to dispose of faeces-free waste water occurring below the flood level of buildings and sites. It defines general requirements as well as principles of construction and testing.

Flood level

Maximum backflow level of waste water in a drainage system

Hydraulic system

The part of the pump in which the kinetic energy is converted into pressure energy

Noise characteristics

The noise emission to be expected, indicated as sound pressure level L_{pA} in dB(A)

Pump

Machine without drive, additional components or accessories

Pump set

Complete pump set consisting of pump, drive, additional components and accessories

Submersible motor pump

Submersible motor pumps are floodable, close-coupled units which are not self-priming. The pumps are usually operated completely submerged. They may be operated outside the fluid for short periods of time, until the minimum fluid level has been reached.

Waste water

Water consisting of a combination of water discharged from households, industrial and other businesses as well as surface water.

1 General

1.1 Principles

This operating manual is supplied as an integral part of the type series and variants indicated on the front cover. The manual describes the proper and safe use of this equipment in all phases of operation.

The name plate indicates the type series/size and main operating data. The serial/series number uniquely identify the system and serve as identification in all further business processes.

In the event of damage, immediately contact your nearest KSB service centre to maintain the right to claim under warranty.

Noise characteristics

1.2 Installation of partly completed machinery

To install partly completed machinery supplied by KSB refer to the sub-sections under Servicing/Maintenance.

1.3 Target group

This operating manual is aimed at the target group of trained and qualified specialist technical personnel. (⇒ Section 2.4, Page 8)

1.4 Other applicable documents

Table 1: Overview of other applicable documents

Document	Contents
Sub-supplier product literature	Operating manuals and other product literature describing accessories and integrated machinery components

For accessories and/or integrated machinery components observe the product literature of the relevant manufacturer.

1.5 Symbols

Table 2: Symbols used in this manual

Symbol	Description
✓	Conditions which need to be fulfilled before proceeding with the step-by-step instructions
▷	Safety instructions
⇒	Result of an action
⇔	Cross-references
1. 2.	Step-by-step instructions
	Note Recommendations and important information on how to handle the product









2 Safety

All the information contained in this section refers to hazardous situations. In addition to the present general safety information the action-related safety information given in the other sections must be observed.

2.1 Key to safety symbols/markings

Table 3: Definition of safety symbols/markings

Symbol	Description
 DANGER	DANGER This signal word indicates a high-risk hazard which, if not avoided, will result in death or serious injury.
 WARNING	WARNING This signal word indicates a medium-risk hazard which, if not avoided, could result in death or serious injury.
 CAUTION	CAUTION This signal word indicates a hazard which, if not avoided, could result in damage to the machine and its functions.
	General hazard In conjunction with one of the signal words this symbol indicates a hazard which will or could result in death or serious injury.
	Electrical hazard In conjunction with one of the signal words this symbol indicates a hazard involving electrical voltage and identifies information about protection against electrical voltage.
	Machine damage In conjunction with the signal word CAUTION this symbol indicates a hazard for the machine and its functions.

2.2 General

This manual contains general installation, operating and maintenance instructions that must be observed to ensure safe pump operation and prevent personal injury and damage to property.

The safety information in all sections of this manual must be complied with.

This manual must be read and completely understood by the specialist personnel/operators responsible prior to installation and commissioning.

The contents of this manual must be available to the specialist personnel at the site at all times.

Information attached directly to the pump must always be complied with and be kept in a perfectly legible condition at all times. This applies to, for example:

- Arrow indicating the direction of rotation
- Markings for connections
- Name plate

The operator is responsible for ensuring compliance with all local regulations not taken into account in this manual.

2.3 Intended use

- The pump (set) must only be operated within the operating limits described in the other applicable documents.
- Only operate pumps/pump sets which are in perfect technical condition.
- Do not operate the pump (set) in partially assembled condition.
- Only use the pump to handle the fluids described in the data sheet or product literature of the pump model or variant.
- Never operate the pump without the fluid to be handled.

- Observe the minimum flow rates indicated in the data sheet or product literature (to prevent overheating, bearing damage, etc.).
- Observe the maximum flow rates indicated in the data sheet or product literature (to prevent overheating, mechanical seal damage, cavitation damage, bearing damage, etc).
- Do not throttle the flow rate on the suction side of the pump (to prevent cavitation damage).
- Consult the manufacturer about any use or mode of operation not described in the data sheet or product literature.

Prevention of foreseeable misuse

- Never exceed the permissible operating limits (pressure, temperature, etc.) specified in the product literature.
- Observe all safety information and instructions in this manual.

2.4 Personnel qualification and training

All personnel involved must be fully qualified to transport, install, operate, maintain and inspect the machinery this manual refers to.

The responsibilities, competence and supervision of all personnel involved in transport, installation, operation, maintenance and inspection must be clearly defined by the operator.

Deficits in knowledge must be rectified by means of training and instruction provided by sufficiently trained specialist personnel. If required, the operator can commission the manufacturer/supplier to train the personnel.

Training on the pump (set) must always be supervised by technical specialist personnel.

2.5 Consequences and risks caused by non-compliance with this manual

- Non-compliance with this operating manual will lead to forfeiture of warranty cover and of any and all rights to claims for damages.
- Non-compliance can, for example, have the following consequences:
 - Hazards to persons due to electrical, thermal, mechanical and chemical effects and explosions
 - Failure of important product functions
 - Failure of prescribed maintenance and servicing practices
 - Hazard to the environment due to leakage of hazardous substances

2.6 Safety awareness

In addition to the safety information contained in this manual and the intended use, the following safety regulations shall be complied with:

- Accident prevention, health and safety regulations
- Explosion protection regulations
- Safety regulations for handling hazardous substances
- Applicable standards, directives and laws

2.7 Safety information for the operator/user

- The operator shall fit contact guards for hot, cold and moving parts and check that the guards function properly.
- Do not remove any contact guards during operation.
- Provide the personnel with protective equipment and make sure it is used.
- Contain leakages (e.g. at the shaft seal) of hazardous fluids handled (e.g. explosive, toxic, hot) so as to avoid any danger to persons and the environment. Adhere to all relevant laws.
- Eliminate all electrical hazards. (In this respect refer to the applicable national safety regulations and/or regulations issued by the local energy supply companies.)
- If shutting down the pump does not increase potential risk, fit an emergency-stop control device in the immediate vicinity of the pump (set) during pump set installation.
- Make sure the system cannot be accessed by unauthorised persons (e.g. children).

2.8 Safety information for maintenance, inspection and installation

- Modifications or alterations of the pump are only permitted with the manufacturer's prior consent.
- Use only original spare parts or parts authorised by the manufacturer. The use of other parts can invalidate any liability of the manufacturer for resulting damage.
- The operator ensures that maintenance, inspection and installation is performed by authorised, qualified specialist personnel who are thoroughly familiar with the manual.
- Only carry out work on the pump (set) during standstill of the pump.
- The pump casing must have cooled down to ambient temperature.
- Pump pressure must have been released and the pump must have been drained.
- When taking the pump set out of service always adhere to the procedure described in the manual. (⇒ Section 6.3, Page 25)
- Decontaminate pumps which handle fluids posing a health hazard.
- As soon as the work has been completed, re-install and/or re-activate any safety-relevant and protective devices. Before returning the product to service, observe all instructions on commissioning. (⇒ Section 6.1, Page 23)

2.9 Unauthorised modes of operation

Never operate the pump (set) outside the limits stated in the data sheet and in this manual.

The warranty relating to the operating reliability and safety of the supplied pump (set) is only valid if the equipment is used in accordance with its intended use.

3 Transport/Temporary Storage/Disposal

3.1 Checking the condition upon delivery

1. On transfer of goods, check each packaging unit for damage.
2. In the event of in-transit damage, assess the exact damage, document it and notify KSB or the supplying dealer (as applicable) and the insurer about the damage in writing immediately.

3.2 Transport

	CAUTION
	<p>Improper pump transport Damage to the pump!</p> <ul style="list-style-type: none"> ▷ To transport the pump/pump set always use the handle provided. ▷ Never suspend the pump (set) from the float switch (type SE only) or the power supply cable for transport. ▷ Prevent the pump (set) from getting knocked or dropped.

3.3 Storage/preservation

	CAUTION
	<p>Damage during storage by frost, humidity, dirt, UV radiation or vermin Corrosion/contamination of the pump!</p> <ul style="list-style-type: none"> ▷ Store the pump (set) in a dry, dark, frost-proof room not exposed to sunlight where the atmospheric humidity is as constant as possible.



Store the pump (set) vertically in a dry, dark, frost-proof room not exposed to sunlight. Under these conditions it does not need additional preservation.

3.4 Return to supplier

1. Drain the pump as per operating instructions. (⇒ Section 8.3, Page 29)
2. Always flush and clean the pump, particularly if it has been used for handling noxious, explosive, hot or other hazardous fluids.
3. If the pump set has handled fluids whose residues could lead to corrosion damage in the presence of atmospheric humidity or could ignite upon contact with oxygen, the pump set must also be neutralised, and anhydrous inert gas must be blown through the pump to ensure drying.
4. Always complete and enclose a certificate of decontamination when returning the pump (set).
Always indicate any safety and decontamination measures taken.
(⇒ Section 12, Page 45)

	NOTE
	<p>If required, a blank certificate of decontamination can be downloaded from the following web site: www.ksb.com/certificate_of_decontamination</p>

3.5 Disposal

	 WARNING
	<p>Fluids, consumables and supplies which are hot and/or pose a health hazard Hazard to persons and the environment!</p> <ul style="list-style-type: none">▷ Collect and properly dispose of flushing fluid and any residues of the fluid handled.▷ Wear safety clothing and a protective mask if required.▷ Observe all legal regulations on the disposal of fluids posing a health hazard.

1. Dismantle the pump (set).
Collect greases and other lubricants during dismantling.
2. Separate and sort the pump materials, e.g. by:
 - Metals
 - Plastics
 - Electronic waste
 - Greases and other lubricants
3. Dispose of materials in accordance with local regulations or in another controlled manner.

4 Description of the Pump (Set)

4.1 General description

	⚠ WARNING
	<p>Pumping of impermissible fluids Hazardous to persons and the environment!</p> <ul style="list-style-type: none"> ▷ Only discharge permissible fluids into the public sewer system. ▷ Check the suitability of pump/system materials.
	CAUTION
	<p>Unsuitable fluids Damage to the pump!</p> <ul style="list-style-type: none"> ▷ Never use the pump to handle corrosive, combustible or explosive fluids. ▷ Never use the pump to transport waste water from toilets and urinal systems. ▷ Do not use the pump for foodstuff applications.

Standard design

- Submersible waste water pump (see submersible motor pump)

Pump for handling seepage water.

Suitable for handling chemically neutral, slightly contaminated waste water as well as wash water.

Variant B/BH

Suitable for handling the above fluids and, in addition:

- Abrasive waste water containing sand

4.2 Designation

Example: Ama-Drainer B 80-40 S

Table 4: Designation key

Code	Description	
Ama-Drainer	Type series	
B	Material	
	B	Wear-resistant variant
	BH	Wear-resistant variant with impeller made of Norihard white cast iron
	- ¹⁾	Design for waste water
80	Discharge nozzle DN	
	80	80 mm
	100	100 mm
40	Motor rating [kW x 10]	
	40	4.0 kW
	75	7.5 kW
S	Float switch	
	S	With float switch
	N	Without float switch

1) Blank = standard design = design for waste water

4.3 Name plate

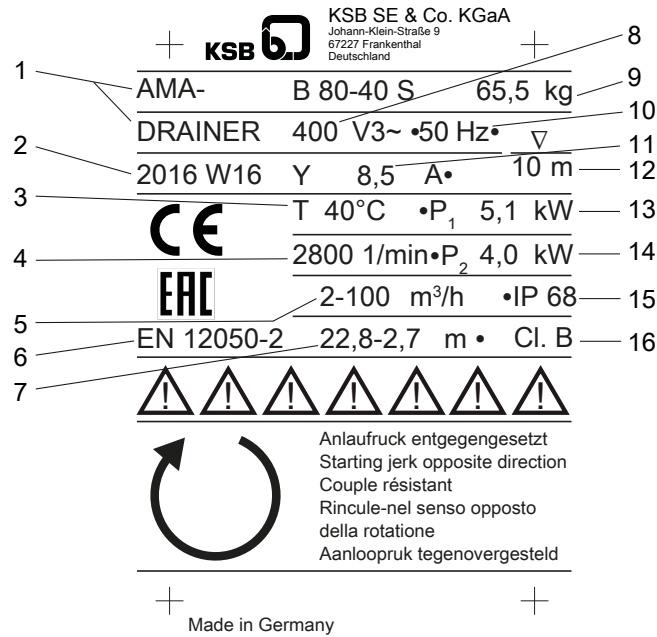

Fig. 1: Name plate (example)

1	Type series / size	2	Year of construction / calendar week (series number)
3	Max. fluid temperature and ambient temperature	4	Rated speed
5	Min./max. flow rate	6	Principles of construction and testing
7	Min./max. head	8	Rated voltage
9	Total weight	10	Rated frequency
11	Rated current	12	Max. installation depth
13	Rated power input	14	Rated pump power output
15	Enclosure	16	Thermal class of winding insulation

4.4 Design details

Design

- Fully floodable submersible motor pump
- To EN 12050-2
- Close-coupled design
- Vertical discharge nozzle
- Single-stage
- Vertical installation
- With or without level control
- All wetted parts made of materials with anti-corrosive coating

Installation types

- Stationary installation
- Transportable installation

Drive

- Motor winding to IEC 60038
- Motor design to EN 60043 T1/IEC 34-1
- Thermal class B
- Starting method: DOL or star-delta
- Enclosure: IP68 (permanently submerged) to EN 60529 / IEC 529

Standard design:

- 10-metre power cable

Variant B/BH:

- 20 m power cable

Ama-Drainer 80 N/S

- Surface-cooled three-phase motor
- Integrated temperature switch
- Power cable and CEE plug with phase inverter
- Direction of rotation indication
- Over-current trip

Ama-Drainer 100 N/S²⁾

- Surface-cooled three-phase motor
- Integrated temperature switch
- Power cable with free cable ends

Shaft seal

- Pump and drive-end mechanical seals
- A lubricant reservoir in-between the sealing elements ensures cooling and lubrication.

Impeller type

- Open multi-channel impeller

Bearings

- Maintenance-free
- Grease-packed rolling element bearings sealed for life

Electrical connection

- **Ama-Drainer (B/BH) 80 pump sets for DOL starting**
Ama-Drainer pump sets for 3~ 400 V are supplied ready to be plugged in. They come with power cable and CEE plug, phase inverter and phase sequence indicator, equipment-on and fault indicator lamp, three-position "manual-0-automatic" switch and motor protection relay.
The plug simply needs to be plugged into a suitable socket.
- **Ama-Drainer (B/BH) 100 pump sets for star-delta starting**
These Ama-Drainer pump sets are supplied with a 4-wire and a 7-wire motor connection cable. The cable ends are marked accordingly. Switchgear with star-delta combination, manual-0-automatic selector switch, motor protection switch and terminals can be supplied as accessories.

2) Switchgear / control unit available separately

4.5 Configuration and function

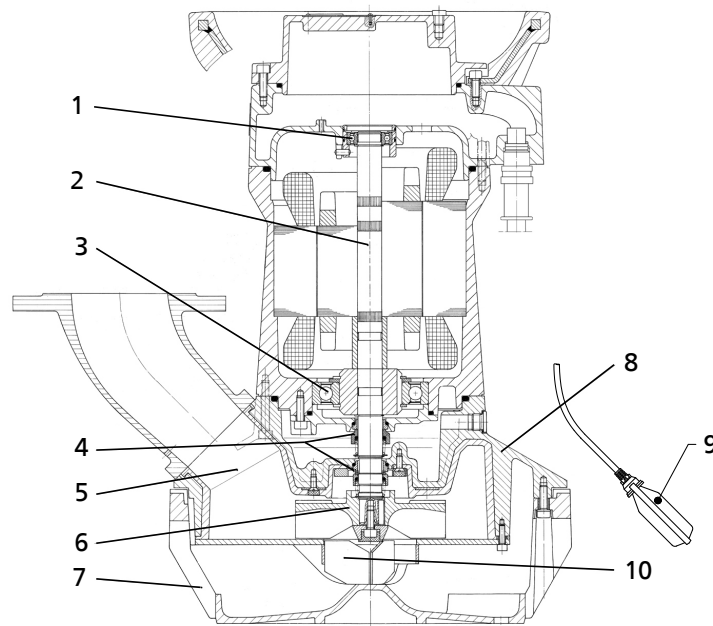

Fig. 2: Sectional drawing

1	Bearing, motor end	2	Shaft
3	Bearing, pump end	4	Shaft seal
5	Discharge nozzle	6	Impeller
7	Foot	8	Volute casing
9	Float switch	10	Suction nozzle

Design The pump is designed with a vertical fluid inlet and a vertical outlet. The hydraulic system sits on the extended motor shaft. The shaft runs in common bearings.

Function The fluid enters the pump axially via the suction nozzle (10) and is accelerated outward by the rotating impeller (6). In the flow passage of the volute casing (8) the kinetic energy of the fluid is converted into pressure energy. The fluid is pumped to the discharge nozzle (5), where it leaves the pump. At the rear side of the impeller, the shaft (2) enters the hydraulic system via the volute casing (8). The shaft passage through the volute casing is sealed to atmosphere with a shaft seal (4). The shaft runs in rolling element bearings (1) and (3).

Sealing The pump is sealed by two bi-rotational shaft seals in tandem arrangement. A lubricant reservoir between the seals serves to cool and lubricate the shaft seals.



NOTE

A special connection elbow is required to connect the piping.

4.6 Scope of supply

Depending on the model, the following items are included in the scope of supply:

- Pump set
- 10-metre power cable

For variant B/BH:

- 20 m power cable

For ... S:

- Float switch

Accessories

Table 5: Piping connection

Piping connection		Ama-Drainer (B)	
		80	100
Special connection elbow made of grey cast iron	Internal thread Rp 2 1/2	X	-
Flanges drilled to DIN 2501, PN 16 Internal thread to DIN 2999/1 (must be ordered separately)	Flange DN 65	X	-
	Flange DN 80	X	-
	Internal thread Rp 4	-	X
	Flange DN 100	-	X

Further required accessories can be purchased from our distributors.

- Control units for trouble-free operation of the pump sets

4.7 Noise characteristics





Sound pressure level < 70 dB(A)

4.8 Dimensions and weights

For dimensions and weights refer to the general arrangement drawing/outline drawing or data sheet of the pump set.

5 Installation at Site

5.1 Safety regulations

	<p>⚠ DANGER</p> <p>Unsuitable electrical installation Danger to life!</p> <ul style="list-style-type: none"> ▷ Make sure the electrical installation meets the VDE 0100 installation rules (i.e. sockets with earthing terminals). ▷ Make sure the electric mains is equipped with a residual current device of maximum 30 mA. ▷ Always have the electrical connections installed by a trained and qualified electrician.
	<p>⚠ DANGER</p> <p>Use in an outdoor area Danger of death from electric shock!</p> <ul style="list-style-type: none"> ▷ Any extension cords must match the quality of the supplied pump cable (10-metre cable length). ▷ Do not expose electrical connections to any moisture.
	<p>⚠ DANGER</p> <p>Faulty power cable Danger of death from electric shock!</p> <ul style="list-style-type: none"> ▷ Have the power cable replaced by a trained electrician.
	<p>⚠ DANGER</p> <p>Continuous pump operation in swimming pools, garden ponds or similar Danger of death from electric shock!</p> <ul style="list-style-type: none"> ▷ Make sure that nobody is in the water while the pump is in operation. ▷ Only use the pump for draining swimming pools, garden ponds, etc. (It is impermissible to use this pump as a recirculation pump, for example.)

5.2 Checks to be carried out prior to installation

Before installing the pump make sure that the following requirements are met:

- Check the data on the name plate of the pump to make sure it can be operated on the available mains.
- The fluid to be handled matches the description of suitable fluids.
- The above safety instructions have been complied with.

5.2.1 Checking the operating data

Before installing the pump set, verify that the name plate data matches the data given in the purchase order and the site system data.

5.2.2 Preparing the place of installation

1. Check the structural requirements.
 All structural work required must have been prepared in accordance with the dimensions stated in the outline drawing/general arrangement drawing.
 (⇒ Section 10.2, Page 38)

5.3 Installing the pump set

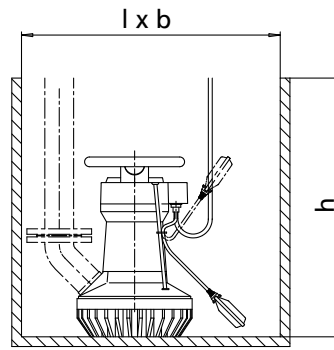

Fig. 3: Dimensions for installation

Table 6: Recommended installation dimensions

Type series	$l \times b^{3)}$	$h^{3)}$
	[mm]	[mm]
All	800 × 800	800

1. For transporting and lifting the pump observe the following notes.
(⇒ Section 3.2, Page 10)
2. If required, suspend the pump using a rope attached to the handle.
3. Place the pump on a solid surface.
4. Make sure that the float can move freely.

5.4 Piping

5.4.1 Connecting the piping

	⚠ DANGER
	<p>Impermissible loads acting on the pump nozzles Danger to life from escaping hot, toxic, corrosive or flammable fluids!</p> <ul style="list-style-type: none"> ▷ Do not use the pump as an anchorage point for the piping. ▷ Anchor the pipes in close proximity to the pump and connect them without transmitting any stresses or strains. ▷ Observe the permissible forces and moments at the pump nozzles. ▷ Take appropriate measures to compensate for thermal expansion of the piping.
	NOTE
	<p>Installing check and shut-off elements in the system is recommended, depending on the type of plant and pump. However, such elements must not obstruct proper drainage or hinder disassembly of the pump.</p>
	NOTE
	<p>The highest point of the discharge line must be above the flood level (usually street level) to prevent any backflow from the sewage system.</p>

3) Minimum values

Transportable version

1. Connect the special connection elbow to a hose with a suitable adapter (e.g. Storz coupling).

Stationary installation

Refer to the relevant installation examples.

5.5 Electrical system

5.5.1 Information for planning the control system

For the electrical connection of the pump set observe the wiring diagrams contained in the Annex.

The pump set is supplied with power cables.

5.5.1.1 Overload protection

The motor is protected by temperature switches (thermal circuit breakers) installed in the motor winding which switch off the pump when the maximum permissible winding temperature is reached and automatically start it up again when the motor has cooled down.

If the thermal motor protection (e.g. motor protection relays or motor protection switch) keeps tripping the pump, contact KSB's inspection service.

- Generally provide an external 3-pole interlocked circuit breaker to ensure complete separation from the mains; this also prevents the pump set from running on two phases only.
- The motor must be protected against overloading by a thermal time-lag overload protection device in accordance with IEC 947 / VDE 0660. The device must be set to the rated motor current. Refer to the name plate for the correct setting value. In addition, the pump must be protected against dry running. The pump set must not be operated without suitable motor and short circuit protection.

Ama-Drainer 80

If the thermal circuit breaker in the motor has tripped the pump, the red fault indicator lamp at the CEE plug will be lit until the motor has cooled down again. The motor re-starts automatically. As additional protection, a motor protection relays is fitted at the CEE plug. It protects the motor against overcurrent but not against short circuit. If the motor protection relay (in the CEE plug) has tripped the pump, the red fault indicator lamp will be lit until the reset key is pressed. The reset-manual-automatic selector switch at the motor protection relay (in the CEE plug) always has to be set to manual; otherwise the reset key cannot be activated and the motor will re-start automatically after the motor protection relay has tripped the pump.

5.5.1.2 Level control

	CAUTION
	<p>Fluid level below the specified minimum Damage to the pump set by cavitation!</p> <p>▷ Never allow the fluid level to drop below the specified minimum.</p>

Automatic operation of the pump set in a tank requires the use of level control equipment.

Observe the minimum fluid level.

Variant S is equipped with a float switch.

The switching level must be set on site.

	NOTE
	<p>The pump set is switched ON/OFF with the float switch at an UPWARD/ DOWNWARD slant of approximately 40° of the float housing (clearly audible switching noise in the float housing).</p>

Setting the switching levels

Observe the following information when setting the switching levels:

- Minimum level of fluid handled
 - The pump must stop before the fluid level falls down to the level of the foot's suction openings.
 - The pump must start up before the fluid level reaches the upper sump edge.
 - The float switch must neither come to rest on the floor nor bump against the top of the unit.
1. Choose an appropriate height for fixing the float switch cable.
 2. Fasten the float switch cable to the discharge line or choose another suitable attachment point.
 The free cable length of the float switch between the attachment point and the anti-kink bush must be at least 100 mm.



When installing 2 pumps controlled by an Ama-Drainer control unit for dual-pump stations, arrange the two float switches in a cascade.

This configuration permits three switching functions:

- Alternating start-up of the two pumps at each switching cycle.
- Additional start-up of the stand-by pump at peak load.
- Start-up of the stand-by pump should the duty pump fail.

For twin pump operation, Ama-Drainer 80 pumps of variant N and 2 float switches with the required cable length must be used; variant S cannot be used as the directly fitted float switch with only 0.5 m cable cannot be connected to the control unit.

5.5.2 Electrical connection

	⚠ DANGER
	<p>Electrical connection work by unqualified personnel Danger of death from electric shock!</p> <ul style="list-style-type: none"> ▷ Always have the electrical connections installed by a trained and qualified electrician. ▷ Observe regulations IEC 60364.
	⚠ WARNING
	<p>Incorrect connection to the mains Damage to the mains network, short circuit!</p> <ul style="list-style-type: none"> ▷ Observe the technical specifications of the local energy supply companies.
	CAUTION
	<p>Improper routing of power cable Damage to the power cables!</p> <ul style="list-style-type: none"> ▷ Never move the power cables at temperatures below - 25 °C. ▷ Never kink or crush the power cables. ▷ Never lift the pump set by the power cables. ▷ Adjust the length of the power cables to the site requirements.



For the electrical connection observe the wiring diagrams (⇒ Section 10.4, Page 42) in the Annex and the information for planning the control system .

The pump set is supplied complete with connection cables. Always use all cables provided and connect all marked cores of the control cable.

Electrical connection

Ama-Drainer pumps in standard design are supplied with a 10-m power cable, variants B/BH are supplied with a 20-m power cable.



- **Type 80 N**
without float switch, with CEE plug type Hyper, including phase inverter, motor protection and manual-0-automatic selector switch
- **Type 80 S**
with float switch (0.5 m cable, directly connected to the motor), with CEE plug type Hyper, including phase inverter, motor protection and manual-0-automatic selector switch
- **Type 100 N**
without float switch, with a 4-wire and a 7-wire motor cable, free cable ends
- **Type 100 S**
with float switch (separate cable of 10 m, variant B/BH 20 m) with a 4-wire and a 7-wire motor cable, free cable ends

	 DANGER
	<p>Operating a pump set that has not been fully connected Explosion hazard! Damage to the pump set!</p> <ul style="list-style-type: none"> ▷ Never start up a pump set with power cables that have not been fully connected or non-operational monitoring devices.

	CAUTION
	<p>Flow-induced motion Damage to the power cable!</p> <ul style="list-style-type: none"> ▷ Run the power cable upwards without slack.

1. Run the power cable upwards without slack and fasten it.
2. Only remove the protective caps from the power cable immediately before connection.
3. If necessary, adjust the length of the power cable to the site requirements.
4. After shortening the cable, correctly re-affix the markings on the individual conductors at the cable ends.

5.6 Checking the direction of rotation

	 WARNING
	<p>Hands inside the pump casing Risk of injuries, damage to the pump!</p> <ul style="list-style-type: none"> ▷ Always disconnect the pump set from the power supply and secure it against unintentional start-up before inserting your hands or other objects into the pump.

	<p style="background-color: yellow; margin: 0;">CAUTION</p> <p>Pump set running dry Increased vibrations! Damage to mechanical seals and bearings!</p> <ul style="list-style-type: none"> ▷ Never operate the pump set for more than 60 seconds outside the fluid to be handled.
	<p style="background-color: yellow; margin: 0;">CAUTION</p> <p>Wrong direction of rotation Damage to the pump!</p> <ul style="list-style-type: none"> ▷ Follow the step-by-step instructions given for checking the direction of rotation.

Ama-Drainer (B) 80 The power cable (CEE plug) has been connected in the factory so that the pump will have the correct direction of rotation, provided that the mains' phase sequence (building supply mains) is correct.

If the direction of rotation is incorrect the yellow indicator lamp at the CEE plug is lit.

1. Start up the pump.

⇒ If the direction of rotation is correct, the pump should show a start reaction in the direction indicated.

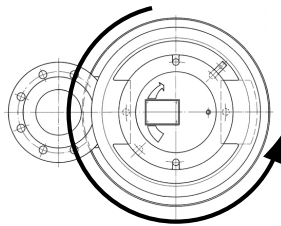

2. If the direction of rotation is incorrect, press in the phase inverter in the CEE plug with an appropriate screwdriver and turn it by 180°.

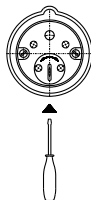

3. If the pump set is connected via a control unit, interchange wires 1 and 2 of the 7-wire cable.

Ama-Drainer (B) 100 Electrical connection is effected via a switchgear (YΔ-starting). If the direction of rotation is incorrect, interchange wires L1 and L2 of the power cable.

1. Start up the pump.

⇒ If the direction of rotation is correct, the pump should show a start reaction in the direction indicated.

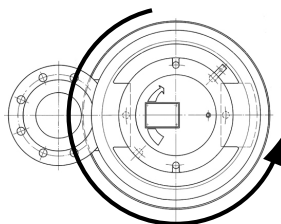

6 Commissioning/Start-up/Shutdown

6.1 Commissioning/Start-up

6.1.1 Prerequisites for commissioning/start-up

Before commissioning/starting up the pump set, make sure that the following conditions are met:

- The operating data has been verified.
- The pump (set) has been installed and connected as described in this manual.
- The pump set has been properly connected to the power supply and is equipped with all protection devices.
- The direction of rotation has been checked.

6.1.2 Starting up/switching off the pump set

Type S with float switch

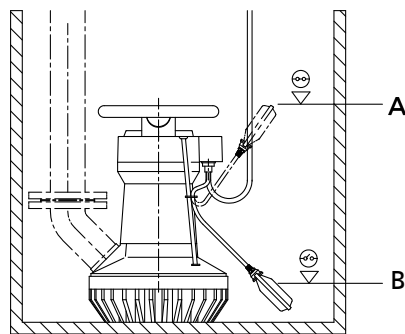

Fig. 4: Start-up/switch-off

A	Start-up level	B	Switch-off level
---	----------------	---	------------------

The pump (set) has been properly connected to the electric power supply

The pump's automatic control system will cut in when level "A" is reached and will cut out when level "B" is reached.

- ✓ The pump (set) has been properly connected to the electric power supply.
 1. Check that the pump operates in submerged condition.

Type N without float switch

- ✓ The pump (set) has been properly connected to the electric power supply.
 1. Check that the pump operates in submerged condition.

6.2 Operating limits

6.2.1 Frequency of starts

	<p>CAUTION</p>
	<p>Excessive frequency of starts Risk of damage to the motor!</p> <ul style="list-style-type: none"> ▸ Never exceed the specified frequency of starts.

To prevent high temperature increases in the motor and excessive loads on the motor, seal elements and bearings, the frequency of starts must not exceed 20 start-ups per hour.

6.2.2 Supply voltage

	CAUTION
	<p>Wrong supply voltage Damage to the pump (set)!</p> <ul style="list-style-type: none"> ▷ The maximum permissible deviation in supply voltage is 10 % of the rated voltage indicated on the name plate. ▷ The maximum permissible voltage difference between the individual phases is 1 %.

6.2.3 Fluid handled

6.2.3.1 Minimum/maximum fluid level

Minimum level of fluid handled

	CAUTION
	<p>Fluid level below the specified minimum Damage to the pump set by cavitation!</p> <ul style="list-style-type: none"> ▷ Never allow the fluid level to drop below the specified minimum.

The pump set is operational when the minimum fluid level is not lower than dimension W_T . This minimum fluid level must also be ensured during automatic operation.

Table 7: Minimum level of fluid handled

Type series	$W_{T \min}$
	[mm]
All	80

Maximum fluid level: (⇒ Section 4.3, Page 13)

Immersion depth

- Standard design 7 m max.
- Variant B/BH 10 m max.

6.2.3.2 Temperature of the fluid handled

	CAUTION
	<p>Incorrect temperature of the fluid handled Damage to the pump (set)!</p> <ul style="list-style-type: none"> ▷ Do not operate the pump (set) outside the specified temperature limits.

Never operate the submerged pump (set) at fluid temperatures exceeding the ones stated below.

- Continuous operation
 - Standard design 50 °C max.
 - Variant B/BH 40 °C max.
- For a short time (up to 3 minutes) 90 °C max.

6.2.3.3 Density of the fluid handled

The pump input power changes in proportion to the density of the fluid handled.

	CAUTION
	<p>Permissible fluid density exceeded Risk of motor overload!</p> <ul style="list-style-type: none"> ▷ Verify the density data against the order data. ▷ Make sure the motor has sufficient power reserves.

The pump (set) is suitable for handling abrasive waste water containing sand but no coarse substances or faeces.

Table 8: Particle size for slightly contaminated waste water

Type series	Max. particle size
	[mm]
All	12

6.3 Shutdown/storage/preservation

6.3.1 Measures to be taken for shutdown

	⚠ WARNING
	<p>Unintentional starting of pump set Risk of injury by moving parts!</p> <ul style="list-style-type: none"> ▷ Ensure that the pump set cannot be started up unintentionally. ▷ Always make sure the electrical connections are disconnected before carrying out work on the pump set.

	⚠ WARNING
	<p>Fluids handled and supplies posing a health hazard and/or hot fluids handled and supplies Risk of injury!</p> <ul style="list-style-type: none"> ▷ Observe all relevant laws. ▷ When draining the fluid take appropriate measures to protect persons and the environment. ▷ Decontaminate pumps which handle fluids posing a health hazard.

1. Disconnect the pump from the power supply and protect it against start-up.
2. Wait until the pump has cooled down (10 minutes), then remove it.
3. Properly flush the pump.
Point the water jet on the pump's discharge nozzle.
4. Leave the pump to dry.
5. Store the pump vertically in a dark, dry and frost-proof room.

6.4 Returning to service

For returning the pump to service observe the sections on commissioning/start-up and the operating limits.

In addition, carry out all servicing/maintenance operations before returning the pump (set) to service.

	NOTE
	<p>On pumps/pump sets older than 5 years we recommend replacing all elastomer seals.</p>

7 Operation

	CAUTION
	<p>Incorrect operation Damage to the pump system!</p> <ul style="list-style-type: none"> ▷ Make sure to comply with all local regulations, particularly the EC Machinery Directive and the EC Directive on Low-Voltage Equipment. ▷ Check all electric cables prior to commissioning/start-up.

7.1 Controlling an Ama-Drainer 80

Variant N:

- | | | |
|-----------------|---|--|
| Switch position | ⬆ | Pump ON (the green equipment-on lamp is lit) |
| Switch position | 0 | Pump OFF |
| Switch position | ⊙ | No function |

Variant S:

- | | | |
|-----------------|---|---|
| Switch position | ⬆ | Pump manually ON (The green equipment-on lamp is lit) |
| Switch position | 0 | Pump OFF |
| Switch position | ⊙ | Pump automatically ON/OFF via float switch (The green equipment-on lamp is lit as long the float switch is in upper float position) |

8 Servicing/Maintenance

8.1 Safety regulations

	⚠ DANGER
	<p>Power supply not disconnected Danger to life!</p> <ul style="list-style-type: none"> ▷ Pull the mains plug or disconnect all electrical connections and secure against unintentional start-up.
	⚠ DANGER
	<p>Work on the pump set by unqualified personnel Danger of death from electric shock!</p> <ul style="list-style-type: none"> ▷ Have pump components modified and dismantled by authorised personnel only.
	⚠ WARNING
	<p>Fluids handled and supplies posing a health hazard and/or hot fluids handled and supplies Risk of injury!</p> <ul style="list-style-type: none"> ▷ Observe all relevant laws. ▷ When draining the fluid take appropriate measures to protect persons and the environment. ▷ Decontaminate pumps which handle fluids posing a health hazard.
	⚠ WARNING
	<p>Improper lifting/moving of heavy assemblies or components Personal injury and damage to property!</p> <ul style="list-style-type: none"> ▷ Use suitable transport devices, lifting equipment and lifting tackle to move heavy assemblies or components.

8.2 Maintenance/inspection

The pump (set) is practically maintenance-free. Slight wear of the mechanical seal is unavoidable. This will be aggravated by abrasive substances contained in the fluid handled.

KSB recommends the following regular maintenance schedule:

Table 9: Overview of maintenance work

Maintenance interval	Maintenance work
Every 2,000 operating hours	Check the lubricant in the lubricant chamber. Check the mechanical seal.

The operating reliability will be improved if proper functioning is checked and verified at regular intervals (EN 12056-4).

8.2.1 Lubrication and lubricant change

8.2.1.1 Lubricant quality

The lubricant reservoir is filled at the factory with environmentally-friendly, non-toxic lubricant of medical quality.

The following oils can be used for lubrication:

Recommended quality of lubricant

- Merkur white oil Pharma 70; producer: DEA
- Thin-bodied paraffin oil; producer: Merck, No.: 7174
- Or an equivalent brand of medical quality, non-toxic

	NOTE
	Only use motor oil if there is no risk of the lubricant contaminating the fluid handled and if the motor oil can be disposed of properly.

8.2.1.2 Lubricant quantity

Table 10: Lubricant quantity

Size	Lubricant quantity
	[l]
80-40	0,8
100-75	1,0

8.2.1.3 Changing the lubricant

	⚠ WARNING
	<p>Lubricants posing a health hazard and/or hot lubricants Hazard to persons and the environment!</p> <ul style="list-style-type: none"> ▸ When draining the lubricant take appropriate measures to protect persons and the environment. ▸ Wear safety clothing and a protective mask, if required. ▸ Collect and dispose of any lubricants. ▸ Observe all legal regulations on the disposal of fluids posing a health hazard.
	⚠ WARNING
	<p>Excess pressure in the lubricant reservoir Liquid spurting out when the lubricant reservoir is opened at operating temperature!</p> <ul style="list-style-type: none"> ▸ Open the screw plug of the lubricant reservoir very carefully.

Draining the lubricant

1. Position the pump set as illustrated.

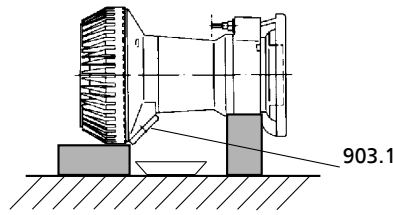

Fig. 5: Draining the lubricant

- 2. Place a suitable container under the screwed plug.
 - 3. Undo screwed plug 903.1 and drain off the lubricant.
- Checking the lubricant**
- 1. Rub the lubricant between your fingers and check its lubricating properties. If the lubricant is dull in appearance or contains grinding particles, the lubricant has to be replaced. A water-oil emulsion (white colour) is of no concern as it is normal for the mechanical seal to leak slightly.
- Filling in the lubricant**
- 1. Position the pump set as illustrated.

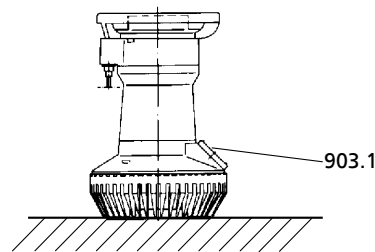

Fig. 6: Filling in the lubricant

- 2. Fill the lubricant through the lubricant filler opening into the lubricant reservoir.
- 3. Replace joint ring 411.1, if required.
- 4. Insert and tighten screwed plug 903.1.



8.3 Drainage/disposal

	<p>⚠ WARNING</p>
	<p>Fluids, consumables and supplies which are hot or pose a health hazard Hazard to persons and the environment!</p> <ul style="list-style-type: none"> ▷ Collect and properly dispose of flushing medium and any residues of the fluid handled. ▷ Wear safety clothing and a protective mask, if required. ▷ Observe all legal regulations on the disposal of fluids posing a health hazard.

The pump will be automatically drained when it is taken out of the fluid handled. Always flush and clean the pump before transporting it to the workshop. Provide a certificate of decontamination for the pump set.

8.4 Dismantling the pump set

8.4.1 General information/Safety regulations

	<p>⚠ DANGER</p> <p>Power supply not disconnected Danger to life!</p> <ul style="list-style-type: none"> ▷ Pull the mains plug or disconnect all electrical connections and secure against unintentional start-up.
	<p>⚠ DANGER</p> <p>Work on the pump set by unqualified personnel Danger of death from electric shock!</p> <ul style="list-style-type: none"> ▷ Have pump components modified and dismantled by authorised personnel only.
	<p>⚠ WARNING</p> <p>Improper lifting/moving of heavy assemblies or components Personal injury and damage to property!</p> <ul style="list-style-type: none"> ▷ Use suitable transport devices, lifting equipment and lifting tackle to move heavy assemblies or components.

8.4.2 Dismantling the pump section

Dismantle the pump section in accordance with the relevant exploded view.

1. Undo socket head cap screws 914.22 and remove duckfoot bend P3.
2. Undo socket head cap screws 914.21.
3. Remove discs 550.3.
4. Remove foot 182.
5. Undo socket head cap screw 914.6.
6. Remove suction cover 162 (for size 100: suction cover with inlet ring 131), profile joint 410.2 and bush 540.1.
7. Pull plug 916.2 out of impeller hub cap 260.
8. Undo socket head cap screw 914.41.
9. Remove impeller hub cap 260.
10. Pull off impeller 230.
(If the impeller is hard to pull off, use a puller with claws.)

8.4.3 Dismantling casing insert 13-6 (variant B/BH only)

1. Remove seven plugs 916.1.
2. Unscrew countersunk screws 900.
3. Remove retaining ring 506.
4. Lift the sealing protuberance of casing insert 13-6 off at the discharge nozzle and press it into the discharge nozzle.
5. Pull the casing insert out of volute casing 102.1.

8.4.4 Removing the mechanical seal



- ✓ The lubricant has been drained. (⇒ Section 8.2.1.3, Page 28)
- ✓ The pump section has been dismantled. (⇒ Section 8.4.2, Page 30)
 1. Remove key 940 and circlip 932.4.
 2. Pull out mechanical seal 433.2.
 3. Unscrew socket head cap screws 914.5.
 4. Remove volute casing 102.1.
 5. Remove circlip 932.11 and adjusting washer 550.2.
 6. Pull off mechanical seal 433.1.
To prevent any damage to the shaft surface caused by the spring when pulling off mechanical seal 433.1, it is recommended to use a special KSB assembly sleeve.

8.4.5 Removing the ball bearings

- ✓ The mechanical seals have been removed. (⇒ Section 8.4.4, Page 31)
 1. Undo three socket head cap screws 914.23.
 2. Take off bearing cover 360.
 3. Pull out the complete rotor assembly.
 4. Remove circlip 932.12.
 5. Pull off ball bearing 321.2 and shaft sleeve 523.
 6. Remove circlip 932.31 or 932.32.
 7. Pull ball bearing 321.1 and bearing sleeve 529 off the shaft.
 8. Remove circlip 932.2.
 9. Press the ball bearing out of the bearing sleeve.

8.5 Reassembling the pump set

8.5.1 General information/Safety regulations

	<p>⚠ WARNING</p>
	<p>Improper lifting/moving of heavy assemblies or components Personal injury and damage to property!</p> <ul style="list-style-type: none"> ▷ Use suitable transport devices, lifting equipment and lifting tackle to move heavy assemblies or components.
	<p>⚠ CAUTION</p>
	<p>Improper reassembly Damage to the pump!</p> <ul style="list-style-type: none"> ▷ Reassemble the pump (set) in accordance with the general rules of sound engineering practice. ▷ Use original spare parts only.

- General**
- Always reassemble the pump in accordance with the corresponding exploded view.
 - Clean all dismantled components and check them for signs of wear.
 - Damaged or worn components are to be replaced by new ones.
 - Always use new tolerance rings.
 - Make sure that the seal faces are clean and that O-rings or gaskets are properly fitted.

- Sealing elements**
- Gaskets

- Always use new gaskets, making sure that they have the same thickness as the old ones.
- Always fit gaskets of asbestos-free materials or graphite without using lubricants (e.g. copper grease, graphite paste).
- **Assembly adhesives**
 - For gaskets, avoid the use of assembly adhesives, if possible.
 - If assembly adhesives are required, use a commercially available contact adhesive (e.g. "Pattex").
 - Only apply adhesive at selected points and in thin layers.
 - Never use quick-setting adhesives (cyanoacrylate adhesives).
 - Coat the locating surfaces of the individual components and screwed connections with graphite or similar before reassembly.

Tightening torques For reassembly, tighten all screws and bolts as specified in this manual.

8.5.2 Installing the ball bearings

1. Insert tolerance ring 500.22 into the shaft.
2. Press ball bearing 321.1 into bearing sleeve 521.
3. Fit circlip 932.2.
4. Press ball bearing 321.1 and bearing sleeve 529 onto the shaft.
5. Insert tolerance ring 500.21 into the shaft.
To protect the shaft surface use the special KSB assembly sleeve.
6. Fit ball bearing 321.2 on shaft sleeve 523 and insert circlip 932.31 or 932.32.
7. Fit circlip 932.12.
8. Insert the complete rotor assembly. Make sure grooved pin 561.2 (anti-rotation device) is fitted properly.
9. Fit bearing cover 360 with O-ring 412.3.
10. Screw in three socket head cap screws 914.23.

8.5.3 Installing the mechanical seal

- ✓ The ball bearings have been installed. (⇒ Section 8.5.2, Page 32)
 - ✓ Use the special KSB assembly sleeve for installing the mechanical seal.
1. Fit mechanical seal 433.1.
 2. Insert adjusting washer 550.2 and circlip 932.11.
 3. Place O-ring 412.4 on motor housing 811.
 4. Fit volute casing 102.1.
 5. Screw in socket head cap screws 914.5.
 6. Fit mechanical seal 433.2.
 7. Fit circlip 932.4.

8.5.4 Fitting casing insert 13-6 (variant B/BH only)

1. Place casing insert 13-6 in volute casing 102.1.
Make sure that the sealing protuberance sits in the recess of the discharge nozzle.
2. Fit retaining ring 506.
3. Screw in countersunk screws 900.
4. Insert seven plugs 916.1.

8.5.5 Installing the pump section

1. Insert key 940.
2. Insert impeller 230.

3. Fit impeller hub cap 260.
4. Screw in socket head cap screw 914.41.
5. Insert plug 916.2 into impeller hub cap 260.
6. Insert profile joint 410.2 as well as bushes 540.1 (for Ama-Drainer B/BH only insert bushes 540.1).
7. Fit suction cover 162 (for size 100 with inlet ring 131).
8. Screw in socket head cap screw 914.6.
9. Fit foot 182.
10. Insert discs 550.3.
11. Screw in socket head cap screws 914.21.
12. Insert duckfoot bend P3.
13. Screw in socket head cap screws 914.22.

8.6 Recommended spare parts stock

It is not necessary to keep spare parts on stock.

9 Trouble-shooting

	⚠ WARNING
	<p>Improper work to remedy faults Risk of injury!</p> <p>▷ For any work to remedy faults observe the relevant information in this manual or in the relevant accessory manufacturer's product literature.</p>
	NOTE
	<p>Before performing any work on the pump's internal parts during the warranty period please always consult the manufacturer. Our after-sales service will be at your disposal. Non-compliance will lead to forfeiture of any and all rights to claims for damages.</p>

If problems occur that are not described in the following table, consultation with the KSB customer service is required.

- A** Pump is running, but does not deliver
- B** Insufficient flow rate
- C** Excessive current/power consumption
- D** Insufficient discharge head
- E** Vibrations and noise during pump operation

Table 11: Trouble-shooting

A	B	C	D	E	Possible causes	Remedy ⁴⁾
-	X	-	-	-	Pump delivers against an excessively high pressure.	Fully open the gate valve.
-	X	-	-	-	Gate valve in the discharge line is not fully open.	Fully open the gate valve.
-	-	X	-	X	Pump running in off-design conditions (low flow / overload)	Check the pump's operating data.
X	-	-	-	-	Pump or piping are not completely vented.	Clean vent bore E in duckfoot bend P3.
X	-	-	-	-	Pump intake clogged by deposits	Clean the intake, pump components and lift check valve.
-	X	-	X	X	Supply line or impeller clogged	Remove deposits in the pump and/or piping.
-	-	X	-	X	Dirt/fibres in the clearance between the casing wall and impeller of a sluggish rotor.	Check whether the impeller can be easily rotated; clean the hydraulic system, if required.
-	X	X	X	X	Wear of internal components	Replace worn components by new ones.
X	X	-	X	-	Defective riser (pipe and sealing element)	Replace defective riser pipe and sealing elements.
-	X	-	X	X	Impermissible air or gas content in the fluid handled	Contact KSB.
-	X	X	X	X	Wrong direction of rotation	If the pump set is running in the wrong direction of rotation, check the electrical connection and the control system, if necessary.
-	-	X	-	-	Operating voltage is too low.	Check mains voltage. Check cable connections.
X	-	-	-	-	Motor is not running because of lack of voltage.	Check electrical installation, inform electric utility company.
X	X	-	X	-	Motor is running on 2 phases only.	Replace defective fuse. Check cable connections.
X	-	-	-	-	Motor winding or electric cable are defective.	Contact KSB's pump service.
-	-	X	-	X	Defective radial bearing in the motor.	Contact KSB.

4) The pump pressure must be released before attempting to remedy faults on parts which are subjected to pressure. Disconnect the pump from the power supply and let it cool down before working on it.

A	B	C	D	E	Possible causes	Remedy ⁴⁾
-	X	X	-	-	Pump clogged by sand, dirt in the pump sump, insufficient inflow.	Clean the intake, sand trap, pump components and check valve. Drain and clean the pump sump.
X	-	-	-	-	Temperature control device monitoring the winding has tripped the pump as a result of excessive winding temperatures.	The motor will restart automatically once the unit has cooled down. Investigate the cause.

10 Related Documents

10.1 Exploded view and list of components

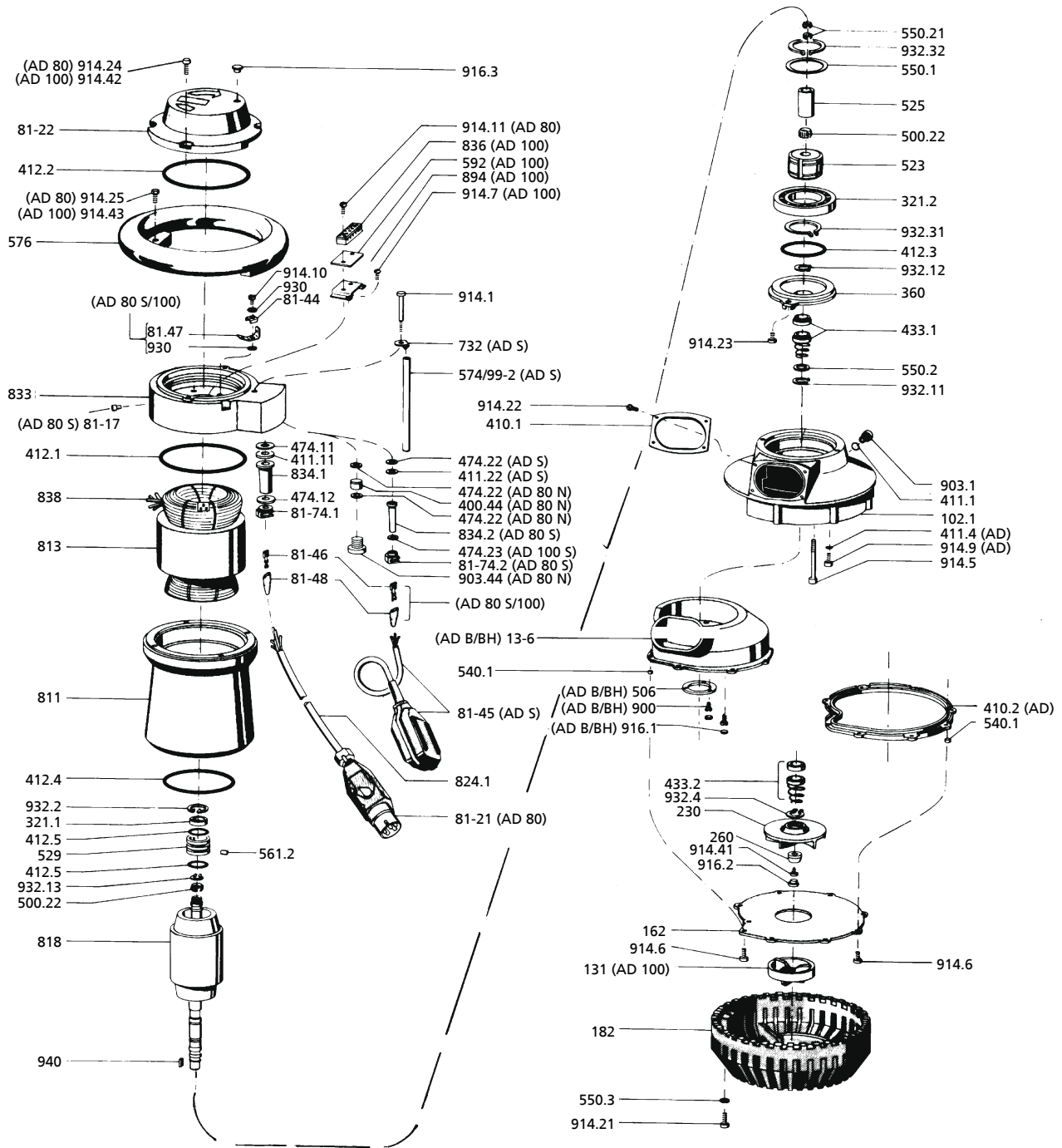

Fig. 7: Exploded view

Part No.	Description
102.1	Volute casing
13-6	Casing insert
131	Inlet ring
162	Suction cover
182	Foot
230	Impeller
260	Impeller hub cap
321.1/2	Deep groove ball bearing

Part No.	Description
360	Bearing cover
400.44	Gasket
410.1/.2 ⁵⁾	Profile seal
411.1/.4 ⁵⁾	Joint ring
411.11/.22	Joint ring
412.1-.5	O-ring
433.1/.2	Mechanical seal
474.11/.12	Thrust ring
474.22/.23	Thrust ring
500.21/.22	Tolerance ring
506	Retaining ring
523	Shaft sleeve
525	Spacer sleeve
529	Bearing sleeve
540.1	Bush
550.1	Support disc
550.2	Adjusting washer
550.3	Disc
561.2	Grooved pin
574	Rod
576	Handle
592	Shim
732	Holder
81-17	End connector
81-21	CEE motor protection plug
81-22	Terminal box cover
81-44	Terminal clamp
81-45	Float switch
81-46	Plug-in sleeve
81-47	Flat connector
81-48	Coupling connector
81-74.1/.2	Pressure screw
811	Motor housing
813	Stator core pack
818	Rotor
824.1	Cable
833	Terminal box
834.1/.2	Cable gland
836	Terminal strip
838	Temperature switch
894	Mounting bracket
900	Countersunk head screw
903.1/.44	Screw plug
914.1/.5/.6/.7	Hexagon socket head cap screw
914.9 ⁵⁾ /.10/.11	Hexagon socket head cap screw
914.21-.25	Hexagon socket head cap screw
914.41/.42	Hexagon socket head cap screw
914.43/.5	Hexagon socket head cap screw

5) Not applicable for Ama-Drainer B/BH

Part No.	Description
916.1/.2/.3	Plug
930	Lock washer
932.11-.13/.2	Circlip
932.31/.32/.4	Circlip
940	Key
99-2	Holder

10.2 Dimensions

10.2.1 Ama-Drainer 80

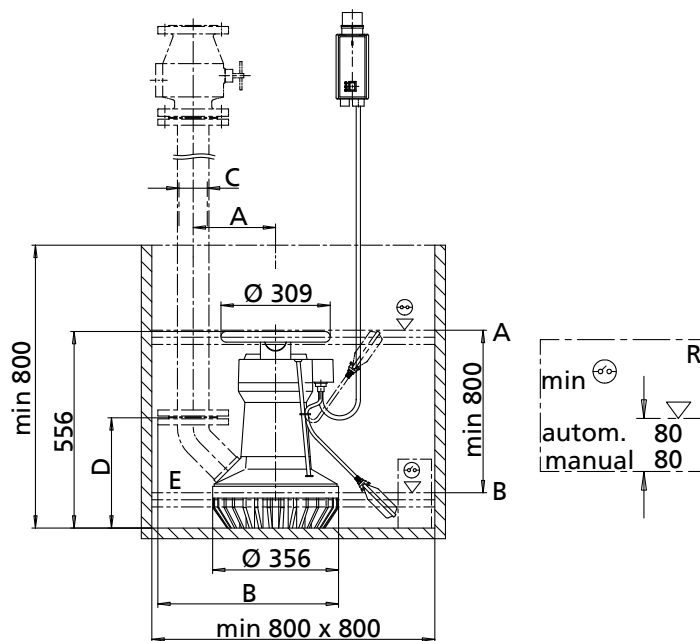

Fig. 8: Outline drawing Ama-Drainer 80

A	Start-up level	B	Switch-off level		
E	Vent hole	R	Residual water level		
Type series	A	B	C	D	Weight
	[mm]				[kg]
Ama-Drainer 80 Duckfoot bend with internal thread Rp 2 1/2	223	445	Rp 2 1/2	314	68
Ama-Drainer 80 Duckfoot bend with flange DN 80	233	511	80	312	70

10.2.2 Ama-Drainer 100

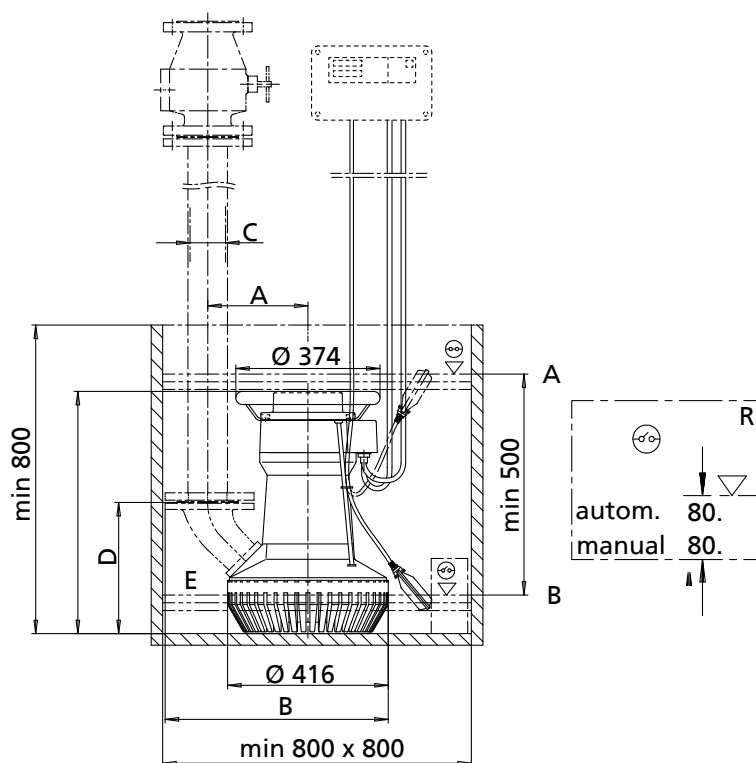

Fig. 9: Outline drawing Ama-Drainer 100

A	Start-up level	B	Switch-off level
E	Vent hole	R	Residual water level

Type series	A	B	C	D	Weight
	[mm]				[kg]
Ama-Drainer 100 Duckfoot bend with internal thread Rp 4	275	546	Rp 4	383	110
Ama-Drainer 100 Duckfoot bend with flange DN 100	260	578	100	340	119

10.3 Installation example

10.3.1 Single pump (installation example)

Suggested connection 1

Hose connection for transportable use (quick connection with Storz coupling)

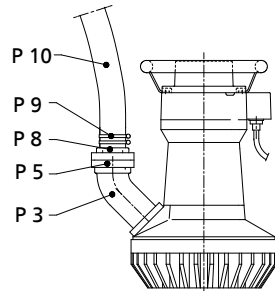

Suggested connection 2

Connection via flanged pipes for stationary use

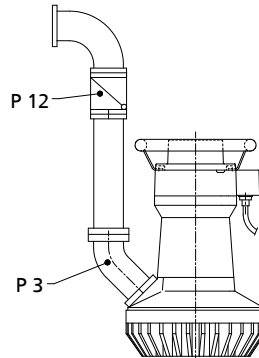

Suggested connection 3

Hose connection for stationary use (quick connection with Storz coupling)

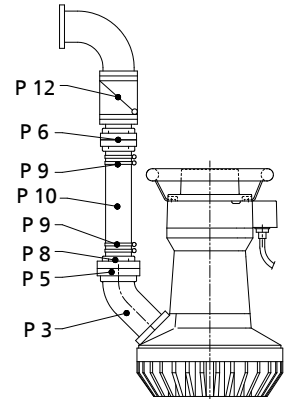

P 3	Connection elbow
P 5	Storz rigid coupling with external thread
P 6	Storz rigid coupling with flange
P 8	Storz hose coupling
P 9	Hose clip
P 10	Plastic hose
P 12	Check valve

10.3.2 Dual-pump station (installation example)

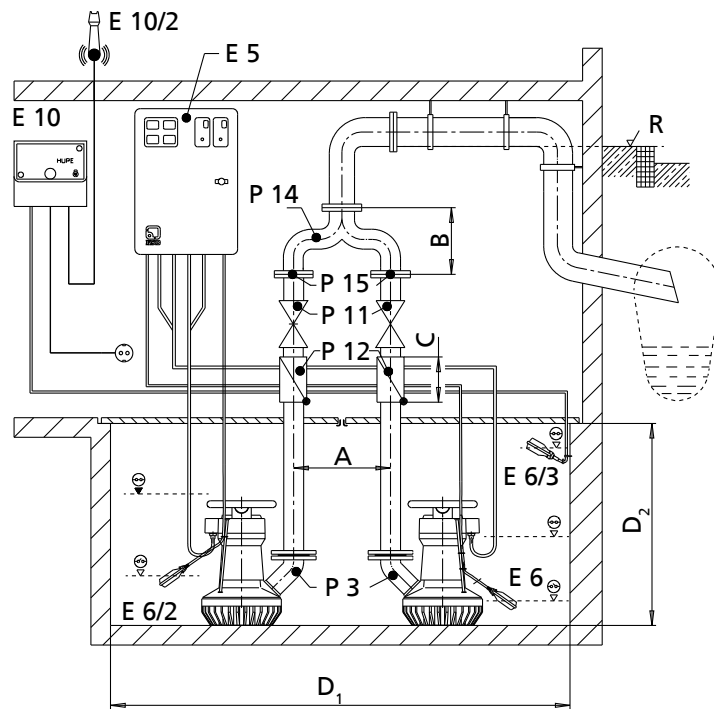

Fig. 10: Installation example in dual-pump station

P 3	Connection elbow				
P 11	Gate valve				
P 12	Swing check valve				
P 14	Y-pipe				
P 15	Threaded flange				
E 5	Control unit				
E 6	Float switch normal water (base load)				
E 6/2	Float switch normal water (peak load)				
E 6/3	Float switch, high water level				
E 10	AS 5 alarm switchgear				
E 10/2	Horn				
R	Flood level				
Size	A	B	C	D ₁	D ₂
	[mm]				
Ama-Drainer 80	350	260	260	1690 x 800	1000
Ama-Drainer 100	325	295	300	1690 x 800	1000

10.4 Wiring diagrams

10.4.1 Ama-Drainer (B) 80-40

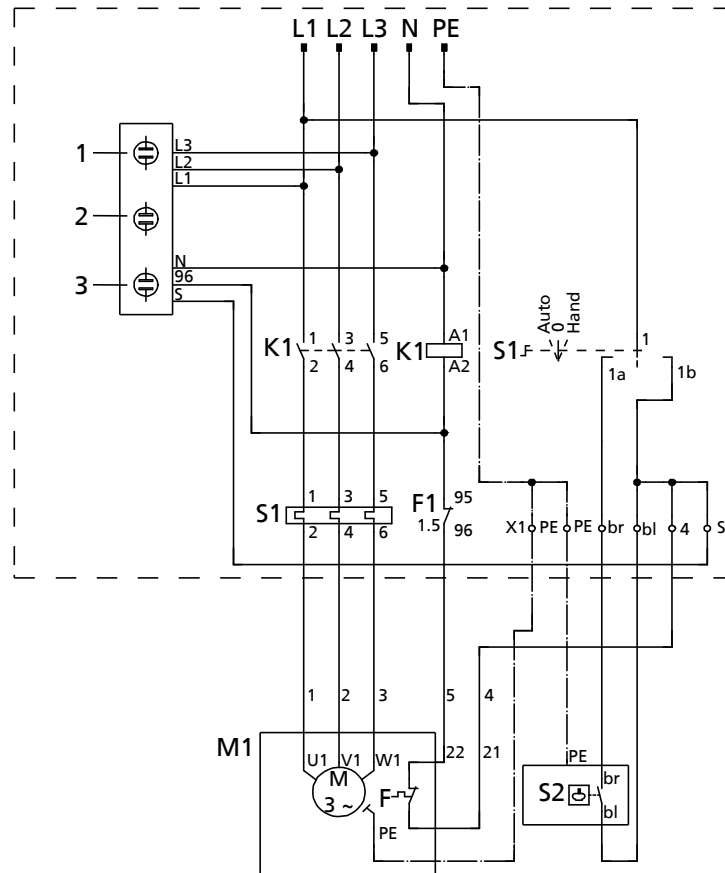

Fig. 11: Wiring diagram Ama-Drainer SE

1	Direction of rotation
2	Operation
3	Fault
K 1	Contactor
S 1	Manual-0-automatic selector switch
F 1	Motor protection relay
X 1	Terminal strip
M 1	Motor
F	Thermal circuit breaker
S 2	Float switch (only for S)
PE	Green/yellow
br	Brown
bl	Blue

10.4.2 Ama-Drainer (B) 100-75 N, S

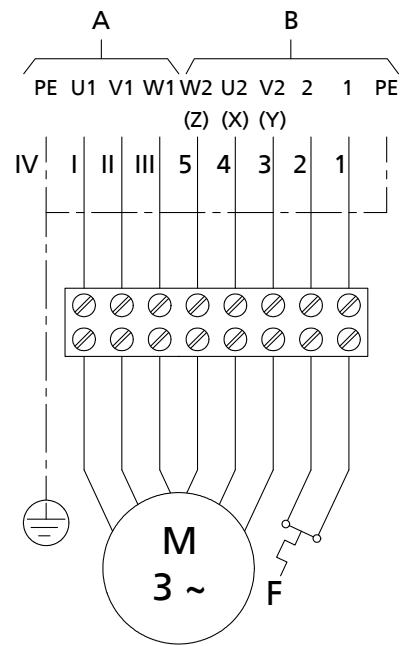

Fig. 12: Wiring diagram Ama-Drainer 100-75 N, S

A	Cable 1
B	Cable 2
M	Motor
F	Thermal circuit breaker
I	black
II	brown
III	grey
IV	green/yellow

11 EU Declaration of Conformity

Manufacturer: **KSB SE & Co. KGaA**
Johann-Klein-Straße 9
67227 Frankenthal (Germany)

The manufacturer herewith declares that the product:

Ama-Drainer (B) 80/100

Series number range: S1616 to S1952

- is in conformity with the provisions of the following Directives as amended from time to time:
 - EC Machinery Directive 2006/42/EC
 - Pump set: Electromagnetic Compatibility Directive 2014/30/EU
 - Construction Products Directive 89/106/EEC

The manufacturer also declares that

- the following harmonised international standards have been applied:
 - ISO 12100
 - EN 809
 - EN 60034-1, EN 60034-5/A1

Certified by TÜV Rheinland LGA Products GmbH (0197)

Person authorised to compile the technical file:

Hugues Roland
Head of Design/Engineering
KSB S.A.S.
128, rue Carnot,
59320 Sequedin (France)

The EU Declaration of Conformity was issued in/on:

Frankenthal, 20 April 2016

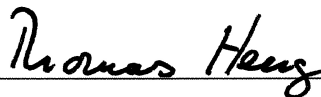

Thomas Heng
Head of Product Development Series Pumps
KSB SE & Co. KGaA
Johann-Klein-Straße 9
67227 Frankenthal

12 Certificate of Decontamination

Type:

Order number/

Order item number⁶⁾:

Delivery date:

Field of application:

Fluid handled⁶⁾:

Please tick where applicable⁶⁾:



Radioactive



Explosive



Corrosive



Toxic



Harmful



Bio-hazardous



Highly flammable



Safe

Reason for return⁶⁾:

Comments:

The product/accessories have been carefully drained, cleaned and decontaminated inside and outside prior to dispatch/ placing at your disposal.

We herewith declare that this product is free from hazardous chemicals, biological and radioactive substances.

For mag-drive pumps, the inner rotor unit (impeller, casing cover, bearing ring carrier, plain bearing, inner rotor) has been removed from the pump and cleaned. In cases of containment shroud leakage, the outer rotor, bearing bracket lantern, leakage barrier and bearing bracket or intermediate piece have also been cleaned.

For canned motor pumps, the rotor and plain bearing have been removed from the pump for cleaning. In cases of leakage at the stator can, the stator space has been examined for fluid leakage; if fluid handled has penetrated the stator space, it has been removed.

- No special safety precautions are required for further handling.
- The following safety precautions are required for flushing fluids, fluid residues and disposal:

.....
.....

We confirm that the above data and information are correct and complete and that dispatch is effected in accordance with the relevant legal provisions.

.....
Place, date and signature

.....
Address

.....
Company stamp

6) Required fields

Index

A

Applications 7

B

Bearings 14

C

Certificate of decontamination 45

Commissioning 23

D

Design 13

Designation 12

Disposal 11

Drive 14

E

Electrical connection 21

Explosion protection 21

F

Faults

Causes and remedies 34

Fluid handled

Density 24

I

Impeller type 14

Installation types 13

Intended use 7

L

Level control system 19

M

Misuse 8

O

Other applicable documents 6

P

Partly completed machinery 6

Product description 12

R

Return to supplier 10

Returning to service 25

S

Safety 7

Safety awareness 8

Scope of supply 16

Shaft seal 14

Shutdown 25

Start-up 23

Switch off 23

T

Transport 10



KSB SE & Co. KGaA

Johann-Klein-Straße 9 • 67227 Frankenthal (Germany)

Tel. +49 6233 86-0

www.ksb.com